

Article number: 3902150056345

Description: Worm gear
VF 150-V-56-112B5, without lubrication

Measures

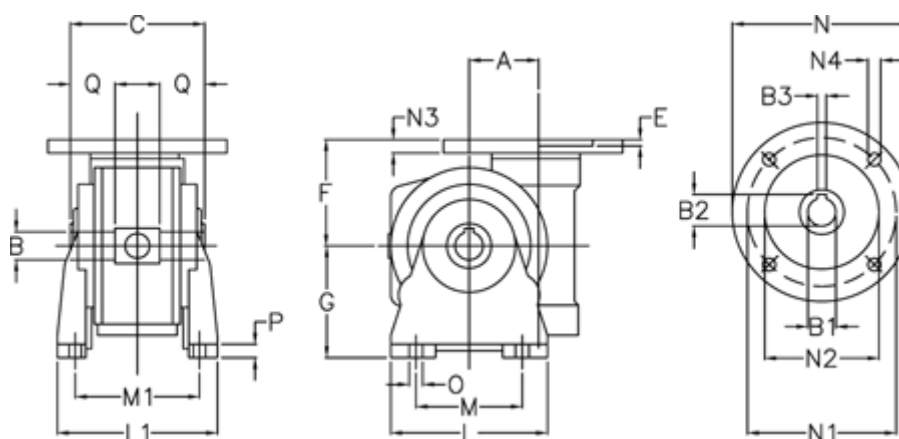

A	= 150	G	= 220	N3	= 11
B	= 50 H7	L	= 330	N4	= 13
B1 E7	= 28	L1	= 260	O	= 18
B2	= 31.3	M	= 240	P	= 20
B3 H9	= 8	M1	= 211	Q	= 55
C	= 175	N	= 250		
E	= 2	N1	= 215		
F	= 190	N2	= 180		